

debar

- Ⓟ Panel ścienny
- Ⓒ Slat Wall
- Ⓓ Wandpaneelen
- Ⓕ Panneau mural

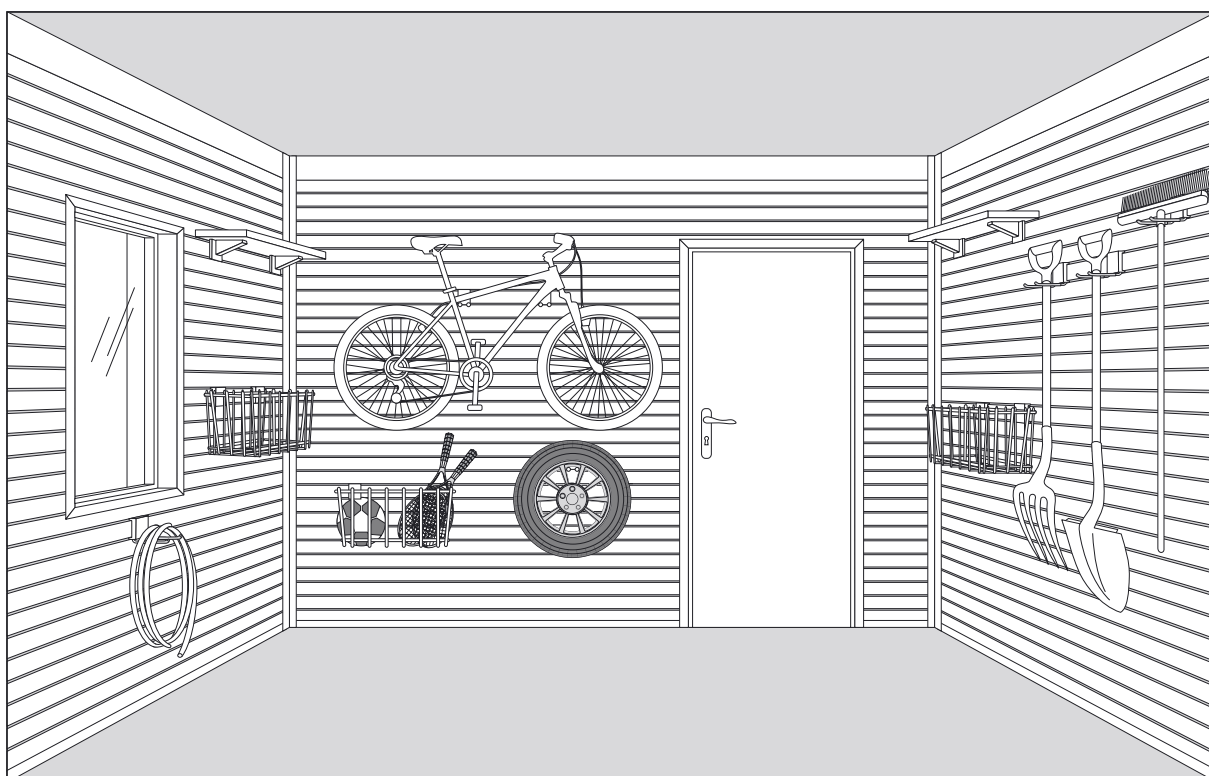
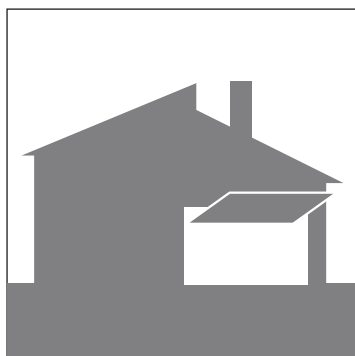
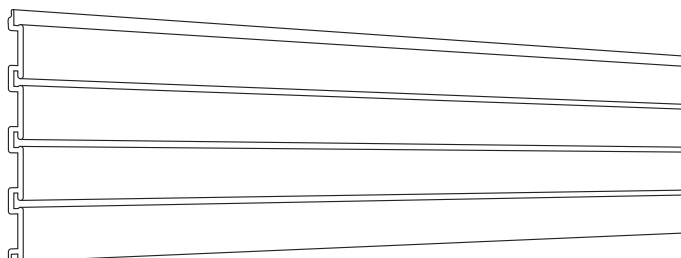

PL UWAGA! Wkręty lub zamocowania potrzebne do przymocowania konstrukcji nośnej do ściany nie zostały zawarte w komplecie. Wybieraj zawsze wkręty i mocowania, które są odpowiednie do twojej ściany i mają wystarczającą wytrzymałość. W przypadku jakichkolwiek wątpliwości skonsultuj się ze specjalistą budowlanym.

GB NOTE! Screws or fittings to fix the supporting structure to the wall are not included. Choose screws and fittings that are specially suited to the material in your wall and have sufficient holding power. If you are uncertain, contact your local construction specialist.

D ACHTUNG! Schrauben oder Beschläge zur Wand- sind nicht beige packt. Achten Sie darauf, dass Sie Schrauben/Beschläge entsprechend der Wand- und mit ausreichender Tragfähigkeit verwenden. Beraten Sie sich beim Baufachmann um richtige Befestigungsart des Systems an die Wand auszuwählen.

F ATTENTION! Les vis et ferrures pour fixer au mur ne sont pas incluses. Pensez à adapter les vis ou ferrures au matériau du mur et au poids de l'objet. En cas de doute, demandez conseil à un spécialiste de construction.

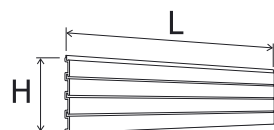
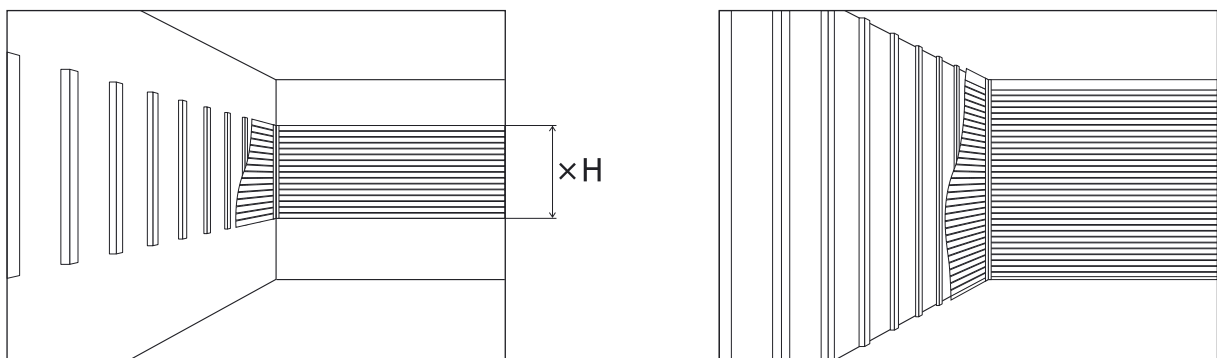

L = 112 cm H = 30 cm

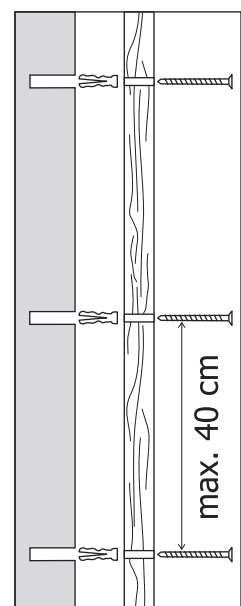
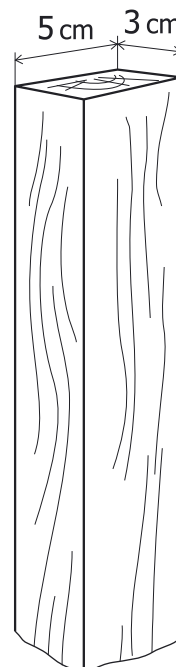
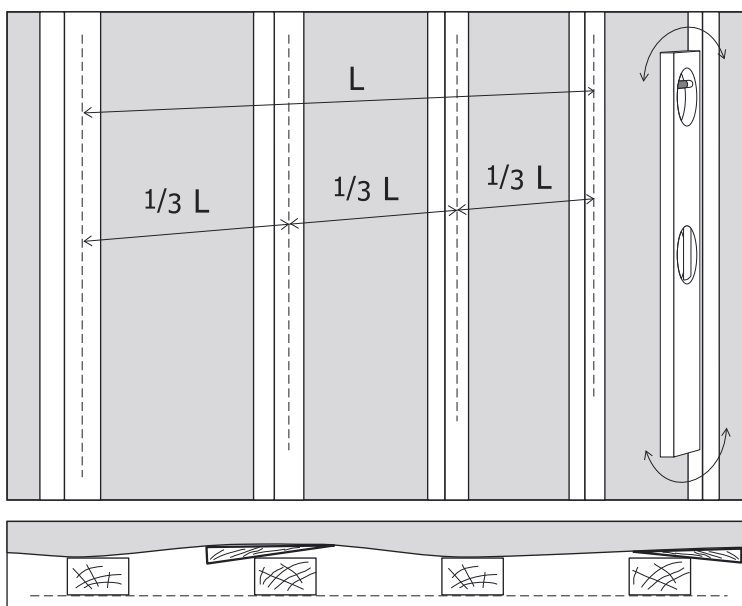

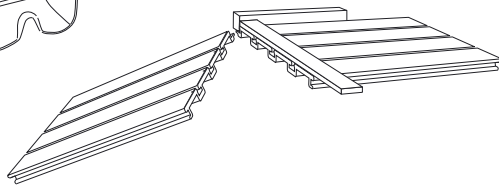
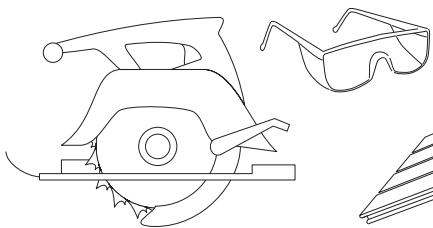
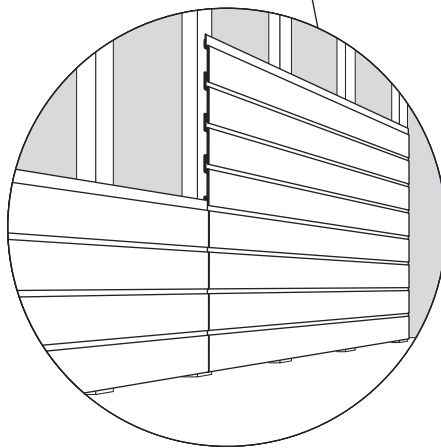
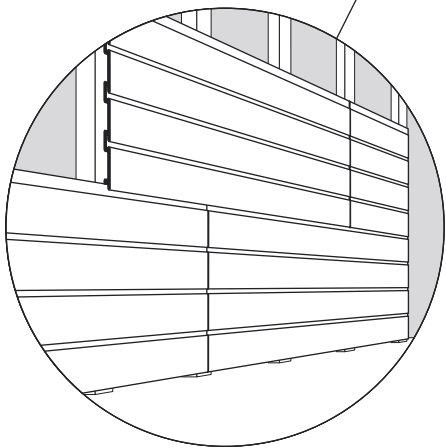
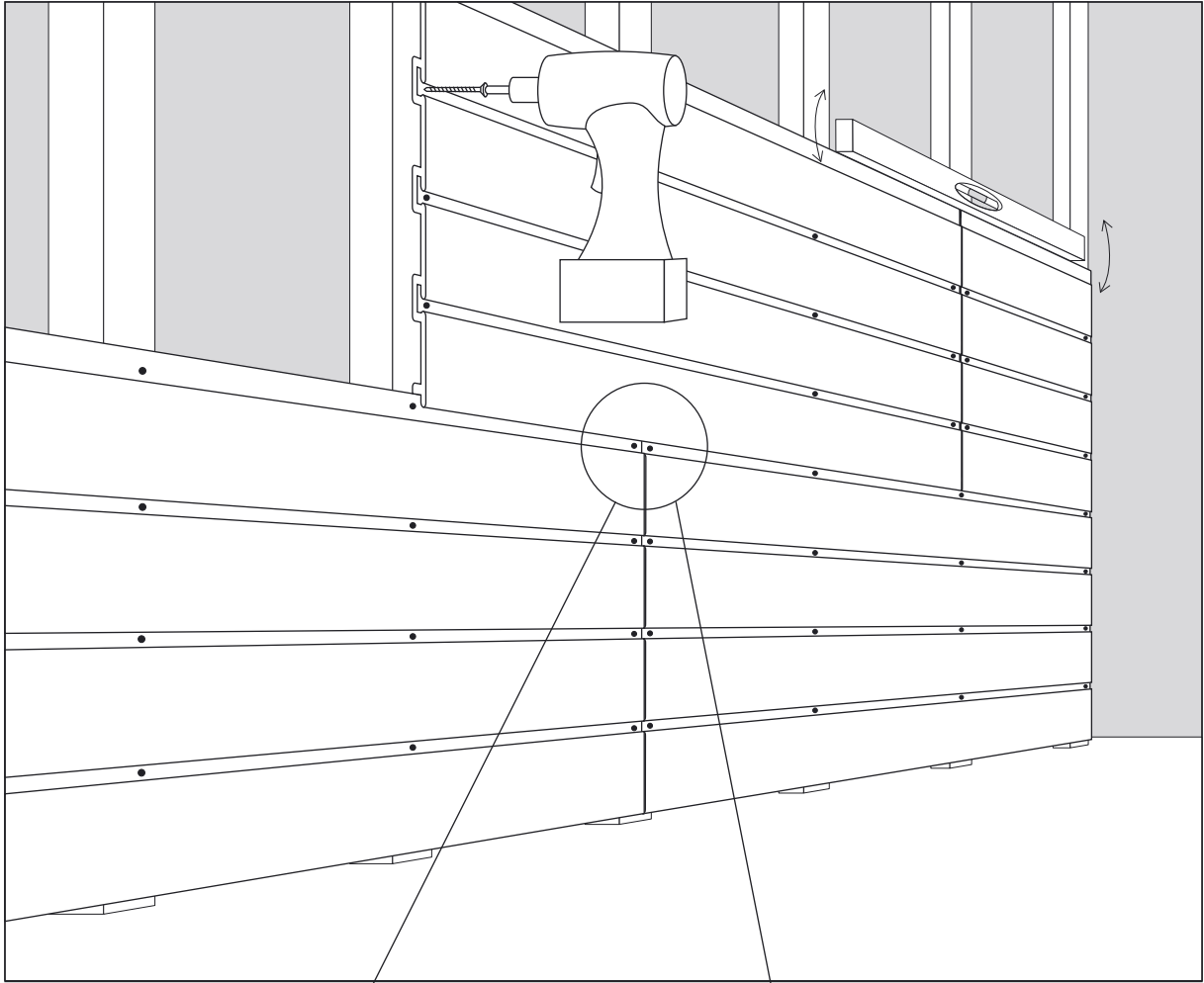

$\varnothing 3,5 \text{ mm}$
35 mm $\times 48/\text{m}^2$

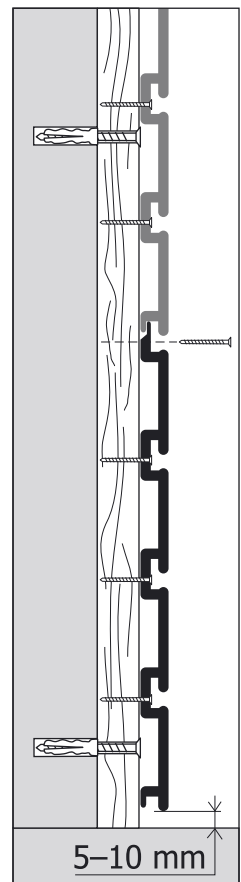

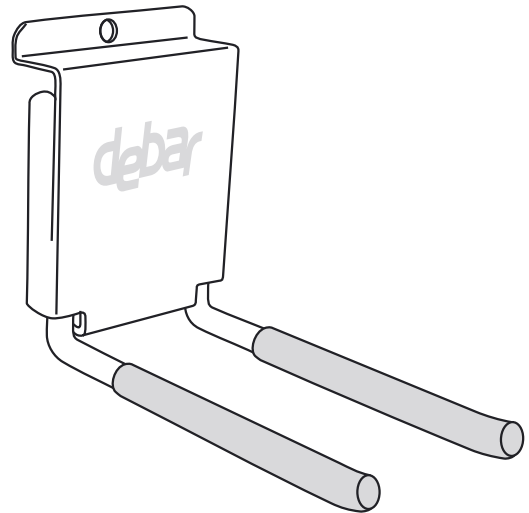
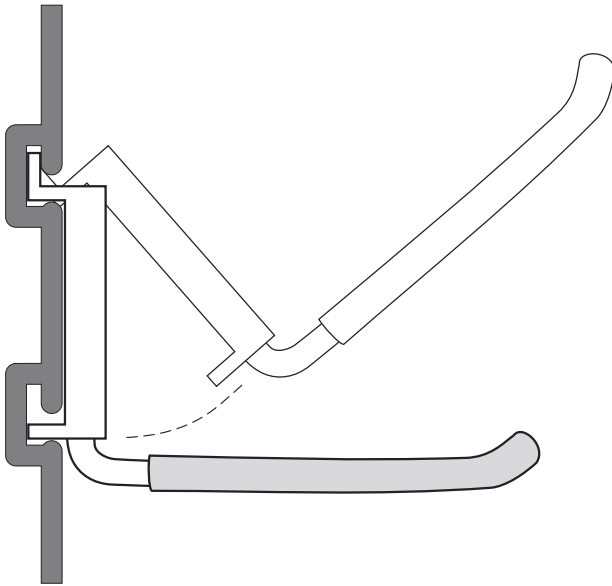
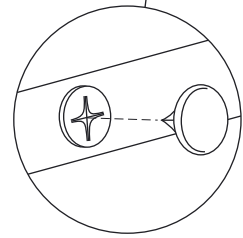
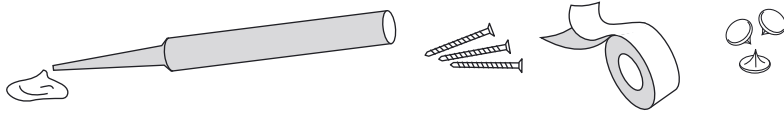
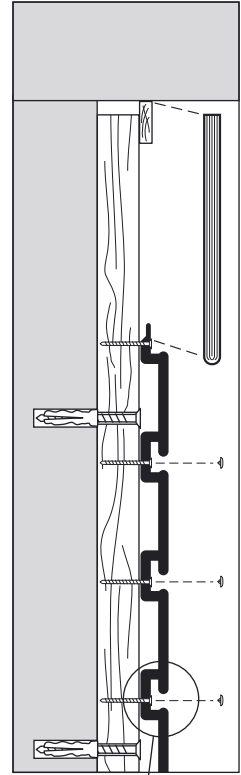
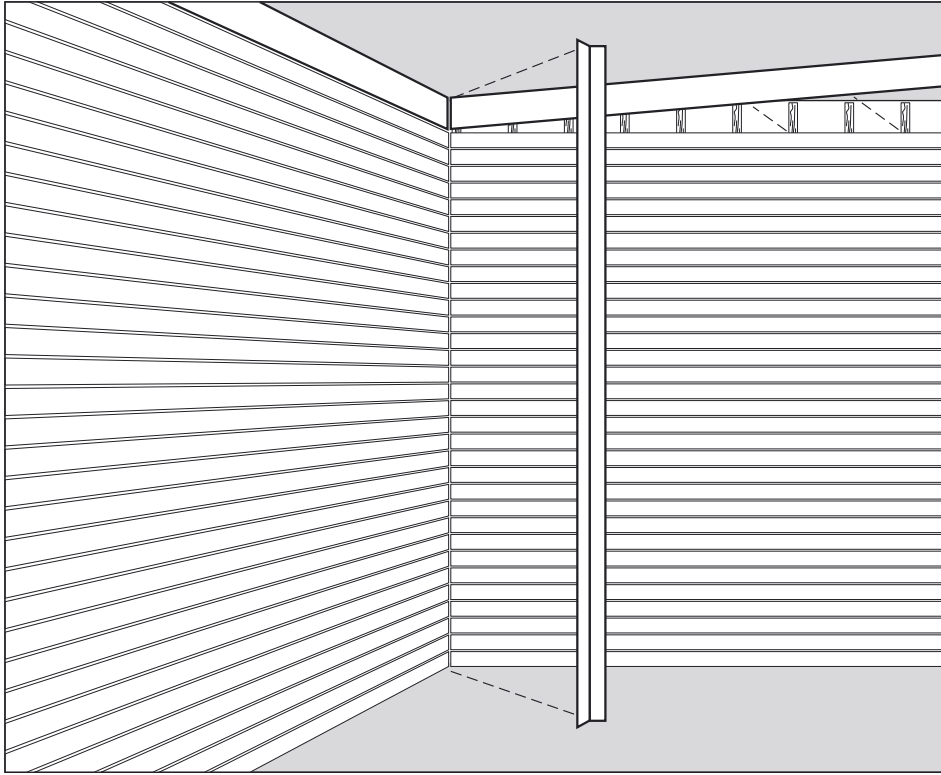

debar

www.debar.info

© 2009 Debar. Made in EU.

Patent EU: 000906862-0001